



A

Profil LED / Profile LED

PL
Profil nawierzchniowy – do podświetlenia dekoracyjnego pomieszczeń biurowych oraz domowych.

EN
Surface-mounted – for decorative lighting in offices and homes.

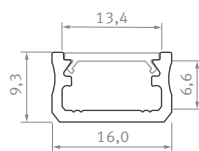

A

Sposoby montażu /
Assembly methods

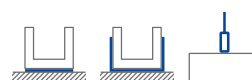





A

A

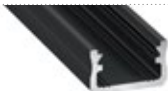

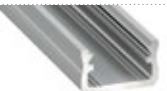







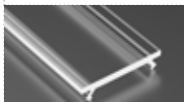

Profil LED / Profile LED

Wymiary [mm] / Dimensions (mm): 1000, 2020, 3000

















	BIAŁY (lakierowany) white (lacquered)	CZARNY (anodowany) black (anodized)	INOX (anodowany) inox (anodized)	SREBRNY (anodowany) silver (anodized)	SUROWY raw
Kolory profili Profile colors					
1,0 m	10-0011-10	10-0012-10	10-0013-10	10-0014-10	10-0010-10
2,02 m	10-0011-20	10-0012-20	10-0013-20	10-0014-20	10-0010-20
3,0 m	10-0011-30	10-0012-30	10-0013-30	10-0014-30	10-0010-30
Szerokość taśmy LED (mm) LED strip width (mm)	do 12 up to 12				

Klosze (PVC/PMMA/PC) / Covers

Wymiary [mm] / Dimensions (mm): 1000, 2020, 3000

TRANSPARENTNY transparent	MROŻONY frozen	MLECZNY milky	FROSTED MLECZNY milky frosted	CZARNY PMMA black PMMA	LENS 15 lens 15	LENS 30 lens 30
BASIC						
						
1 m/PMMA 11-2350-10 1 m/PC 11-3013-10	1 m/PMMA 11-2302-10 1 m/PC 11-3012-10	1 m/PMMA 11-2251-10 1 m/PC 11-3011-10	1 m/PMMA 11-2406-10	1 m/PMMA 11-2017-10	1 m/PMMA 11-2060-10	1 m/PMMA 11-2080-10
HIGH						
						
1 m/PMMA 11-2053-10	1 m/PMMA 11-2052-10	1 m/PMMA 11-2051-10	1 m/PMMA 11-2056-10	1 m/PMMA 11-2057-10		

Zaślepki (aluminium i tworzywo sztuczne) / End caps (aluminum and plastic)

Z OTWOREM with a hole				BEZ OTWORU without a hole			
BIAŁY white	CZARNY black	INOX inox	SREBRNY / SZARY silver / gray	BIAŁY white	CZARNY black	INOX inox	SREBRNY / SZARY silver / gray
BASIC							
							
ABS 12-0011-00	ALU 12-0012-10 ABS 12-0012-00	ABS 12-0013-00	ALU 12-0015-10 ABS lacq. 12-0000-34 ABS 12-0014-00	ABS 12-0011-01	ABS 12-0012-01	ABS 12-0013-01	ALU 12-0015-11 ABS lacq. 12-0000-20 ABS 12-0014-01
HIGH							
							
ABS 12-0021-00	ALU 12-0022-10 ABS 12-0022-00	ABS 12-0023-00	ALU 12-0025-10 ABS lacq. 12-0000-34 ABS 12-0024-00	ABS 12-0021-01	ABS 12-0022-01	ABS 12-0023-01	ALU 12-0025-11 ABS lacq. 12-0000-33 ABS 12-0024-01

Dodatki / Accessories

TRANSPARENTNY, BIAŁY, CZARNY transparent, white, black								
UCHWYT A MINI mounting clip A MINI	UCHWYT A mounting clip A	UCHWYT A HIGH mounting clip A HIGH	UCHWYT A METALOWY metal mounting clip A	UCHWYT A KĄTOWY angled mounting clip A	ZAWIAS hinge	WŁĄCZNIK BEZDOTYKOWY contactless switch	UCHWYT NA PRZEWÓD ϕ 5 mm cable ϕ 5 mm holder	ZAWIESIA pendants
								
13-0023-00	13-0013-00	13-0033-00	13-0110-02	13-0093-00	14-6045-00	14-7052-00	*T 14-7067-00 *B 14-7067-02	*S 14-2011-02 *B 14-2076-00 *W 14-2075-00

* S SREBRNY silver; * B CZARNY black; * T TRANSPARENTNY transparent; * W BIAŁY white

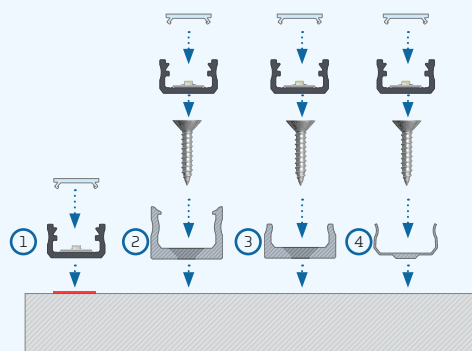

PL
Instrukcja montażu profilu A z kloszem BASIC, [1] z taśmą dwustronną, [2] z uchwytem montażowym A, [3] z uchwytem A MINI, [4] z uchwytem metalowym A.

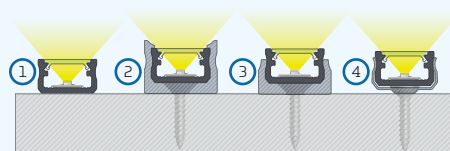

EN
Installation manual for A profile with BASIC cover, [1] with double-sided tape, [2] with a mounting clip for A, [3] with A MINI mounting clip, [4] with metal mounting clip A.

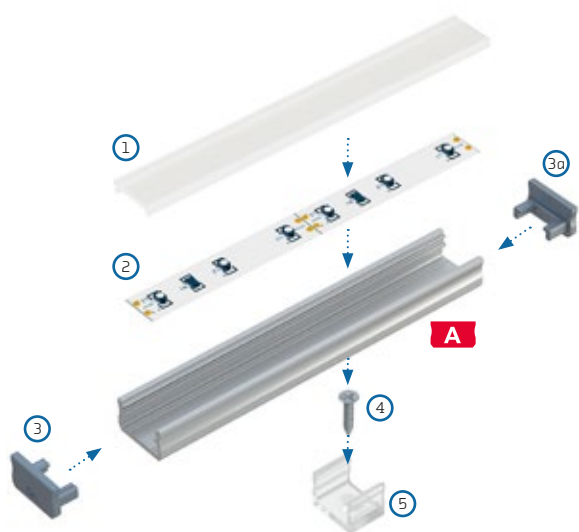

PL
Schemat złożenia elementów systemu oświetleniowego z wykorzystaniem profilu A oraz [1] klosza BASIC, [2] taśmy LED, [3] zaśleпки z otworem, [3a] zaśleпки bez otworu, [4] wkrętu montażowego, [5] uchwytem montażowym A MINI.

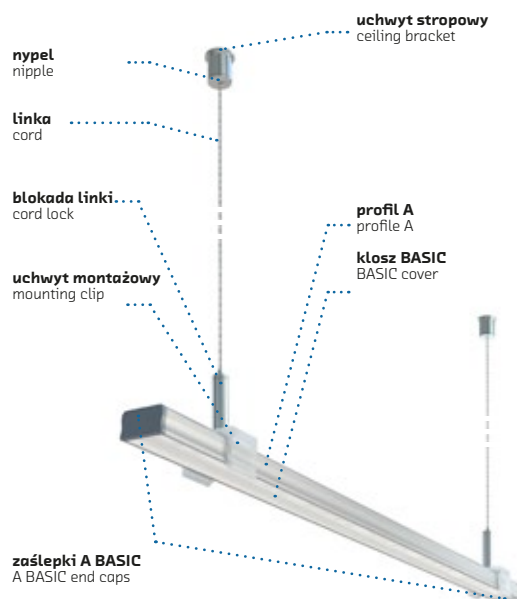

EN
Assembly scheme for elements of the lighting system using a profile A and [1] a BASIC cover, [2] a LED strip, [3] an end cap with hole, [3a] an end cap without hole, [4] a mounting screw, [5] a MINI mounting clip for profile A.