

D

Profil LED / Profile LED

PL
Profil nawierzchniowy – do oświetlenia pomieszczeń kuchennych, sklepowych – oświetlenie szaf, blatów, schodów.

EN
Surface-mounted profile – for lighting kitchens and stores – lighting for shelves, countertops, stairs.

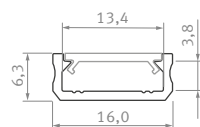

D

Sposoby montażu / Assembly methods

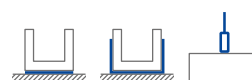





D

D





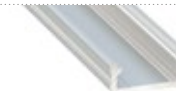





Profil LED / Profile LED

Wymiary [mm] / Dimensions (mm): 1000, 2020, 3000

	BIAŁY (lakierowany) white (lacquered)	CZARNY (anodowany) black (anodized)	INOX (anodowany) inox (anodized)	SREBRNY (anodowany) silver (anodized)	SUROWY raw
Kolory profili Profile colors					
1,0 m	10-0041-10	10-0042-10	10-0043-10	10-0044-10	10-0040-10
2,02 m	10-0041-20	10-0042-20	10-0043-20	10-0044-20	10-0040-20
3,0 m	10-0041-30	10-0042-30	10-0043-30	10-0044-30	10-0040-30
Szerokość taśmy LED (mm) LED strip width (mm)	do 12 up to 12				

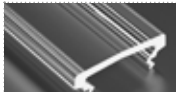
Klosze (PVC/PMMA/PC) / Covers





Wymiary [mm] / Dimensions (mm): 1000, 2020, 3000

TRANSPARENTNY transparent	MROŻONY frozen	MLECZNY milky	FROSTED MLECZNY milky frosted	CZARNY PMMA black PMMA	LENS 15 lens 15	LENS 30 lens 30
BASIC						
						
1 m/PMMA 11-2350-10 1 m/PC 11-3013-10	1 m/PMMA 11-2302-10 1 m/PC 11-3012-10	1 m/PMMA 11-2251-10 1 m/PC 11-3011-10	1 m/PMMA 11-2406-10	1 m/PMMA 11-2017-10	1 m/PMMA 11-2060-10	1 m/PMMA 11-2080-10
HIGH						
						
1 m/PMMA 11-2053-10	1 m/PMMA 11-2052-10	1 m/PMMA 11-2051-10	1 m/PMMA 11-2056-10	1 m/PMMA 11-2057-10		

Zasłepki (aluminium i tworzywo sztuczne) / End caps (aluminum and plastic)

Z OTWOREM with a hole				BEZ OTWORU without a hole			
BIAŁY white	CZARNY black	INOX inox	SREBRNY / SZARY silver / gray	BIAŁY white	CZARNY black	INOX inox	SREBRNY / SZARY silver / gray
BASIC							
							
ABS 12-0051-00	ABS 12-0052-00	ABS 12-0053-00	ABS 12-0054-00	ABS 12-0051-01	ABS 12-0052-01	ABS 12-0053-01	ABS 12-0054-01
	ALU 12-0052-10		ALU 12-0055-10 ALU lacq. 12-0000-41		ALU 12-0052-11		ALU 12-0055-11 ALU lacq. 12-0000-42
HIGH							
							
ABS 12-0061-00	ABS 12-0062-00	ABS 12-0063-00	ABS 12-0064-00	ABS 12-0061-01	ABS 12-0062-01	ABS 12-0063-01	ABS 12-0064-01
	ALU 12-0062-10		ALU 12-0065-10 ALU lacq. 12-0000-40		ALU 12-0062-11		ALU 12-0065-11 ALU lacq. 12-0000-39

Dodatki / Accessories

UCHWYT D MINI mounting clip D MINI	UCHWYT D HIGH mounting clip D HIGH	UCHWYT D METALOWY metal mounting clip D	ZAWIAS hinge
			
13-0053-00	13-0063-00	13-0140-02	14-6045-00

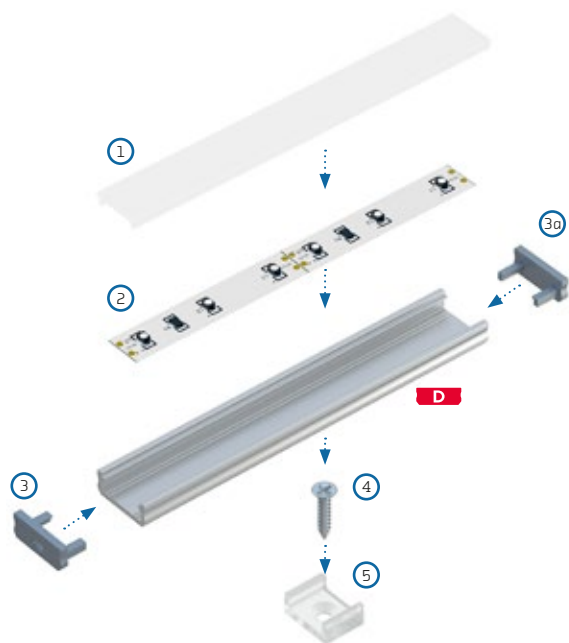

PL

Schemat złożenia elementów systemu oświetleniowego z wykorzystaniem profilu D oraz [1] klosza BASIC, [2] taśmy LED, [3] zaślepki z otworem, [3a] zaślepki bez otworu, [4] wkrętu montażowego, [5] uchwytem montażowego D MINI.

EN

Assembly scheme for elements of the lighting system using [1] a BASIC cover, [2] a LED strip, [3] an end cap with hole, [3a] an end cap without hole, [4] a mounting screw, [5] with a D MINI mounting clip.

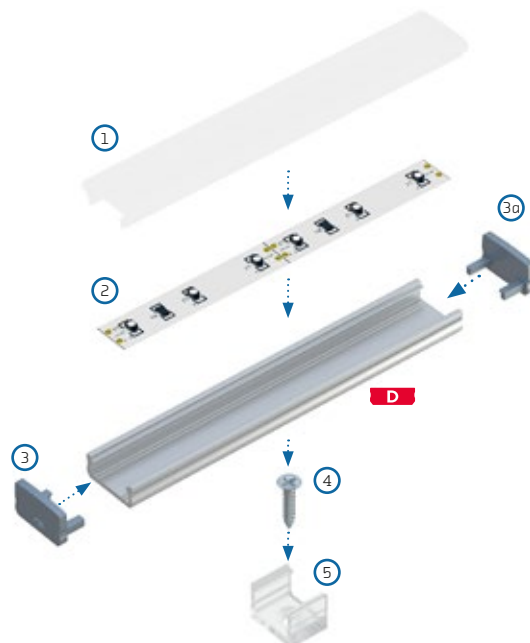

PL

Schemat złożenia elementów systemu oświetleniowego z wykorzystaniem profilu D oraz [1] klosza HIGH, [2] taśmy LED, [3] zaślepki z otworem, [3a] zaślepki bez otworu, [4] wkrętu montażowego, [5] uchwytem montażowego D HIGH.

EN

Assembly scheme for elements of the lighting system using [1] a HIGH cover, [2] a LED strip, [3] an end cap with hole, [3a] an end cap without hole, [4] a mounting screw, [5] with a D HIGH mounting clip.

