



G

Profil LED / Profile LED

PL

Profil wpuszczany – do oświetlenia pomieszczeń kuchennych, sklepowych – oświetlenie szaf, blatów, schodów.

EN

Groove mounted profile – for lighting kitchens and stores – lighting for shelves, countertops, stairs.

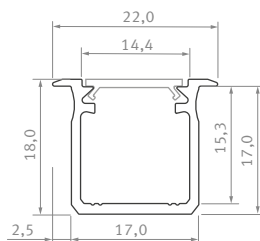

Sposoby montażu /
Assembly methods







G

G







Profil LED / Profile LED

Wymiary [mm] / Dimensions (mm): 1000, 2020, 3000

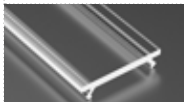
	BIAŁY (lakierowany) white (lacquered)	CZARNY (anodowany) black (anodized)	INOX (anodowany) inox (anodized)	SREBRNY (anodowany) silver (anodized)	SUROWY raw
Kolory profili Profile colors					
1,0 m	10-0071-10	10-0072-10	10-0073-10	10-0074-10	10-0070-10
2,02 m	10-0071-20	10-0072-20	10-0073-20	10-0074-20	10-0070-20
3,0 m	10-0071-30	10-0072-30	10-0073-30	10-0074-30	10-0070-30
Szerokość taśmy LED (mm) LED strip width (mm)	do 12 up to 12				

Klosze (PVC/PMMA/PC) / Covers

Wymiary [mm] / Dimensions (mm): 1000, 2020, 3000

TRANSPARENTNY transparent	MROŻONY frozen	MLECZNY milky	FROSTED MLECZNY milky frosted	CZARNY PMMA black PMMA	LENS 15 lens 15	LENS 30 lens 30
BASIC						
						
1 m/PMMA 11-2350-10 1 m/PC 11-3013-10	1 m/PMMA 11-2302-10 1 m/PC 11-3012-10	1 m/PMMA 11-2251-10 1 m/PC 11-3011-10	1 m/PMMA 11-2406-10	1 m/PMMA 11-2017-10	1 m/PMMA 11-2060-10	1 m/PMMA 11-2080-10

Zaślepki (aluminium i tworzywo sztuczne) / End caps (aluminum and plastic)

Z OTWOREM with a hole			
BIAŁY white	CZARNY black	INOX inox	SREBRNY / SZARY silver / gray
BASIC			
			
ABS 12-0071-00	ALU 12-0072-10 ABS 12-0072-00	ABS 12-0073-00	ALU 12-0075-10 ABS lacq. 12-0000-49 ABS 12-0074-00

Dodatki / Accessories

PROFIL MONTAŻOWY Y M1 assembly profile Y M1	WŁĄCZNIK BEZDOTYKOWY contactless switch
	
10-0654-10	14-7052-00

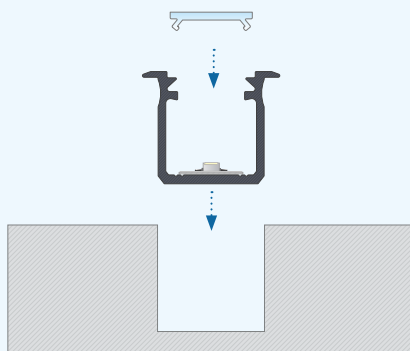

PL
Instrukcja montażu profilu G wpuszczanego z kloszem BASIC.

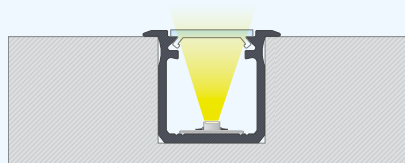

EN
Installation instruction for recessed profile G with a BASIC cover.

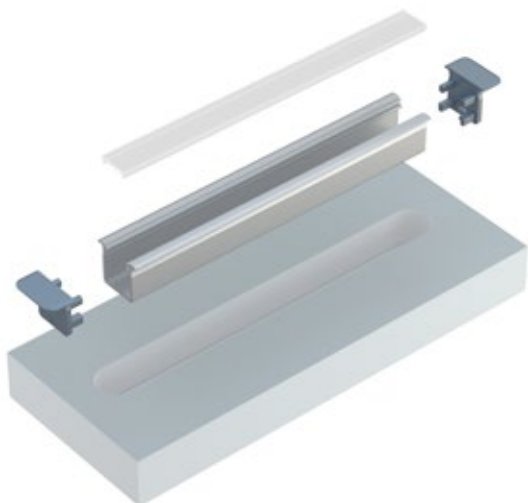

PL
Rzut aksonometryczny przed montażem profilu G wewnątrz wyfrezowanego otworu z kloszem BASIC oraz zaślepkami bocznymi.

EN
Isometric view before mounting profile G inside a milled groove with BASIC cover and end caps.



PL
Efekt końcowy montażu profilu G wpuszczanego z kloszem BASIC w płycie gipsowej.

EN
The end result of installation of recessed profile G with a BASIC cover in a plasterboard.

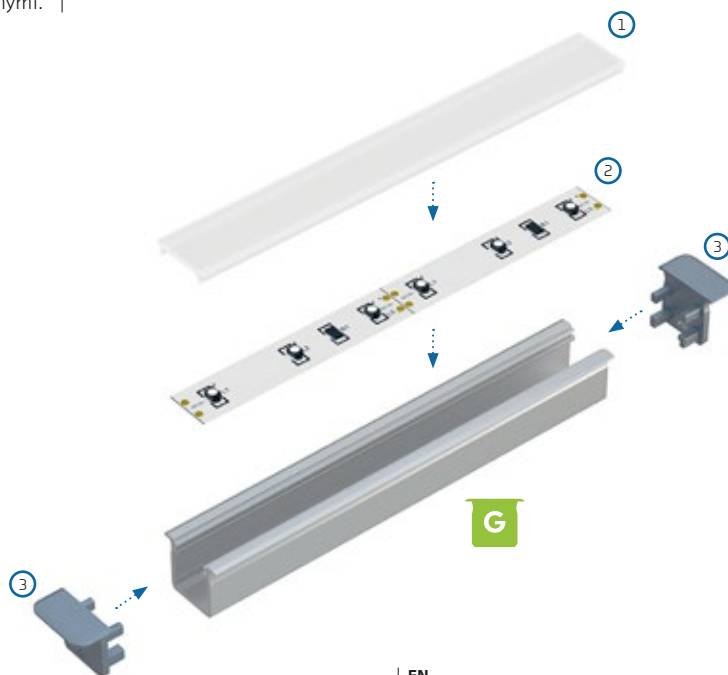

PL
Schemat złożenia elementów systemu oświetleniowego z wykorzystaniem profilu G oraz [1] klosza BASIC, [2] taśmy LED, [3] zaślepek z otworami.

EN
Assembly schematic for the elements of the lighting system using recessed profile G and [1] a BASIC cover, [2] a LED strip, [3] end caps with hole.